

Retrofit Instructions:

Step 1

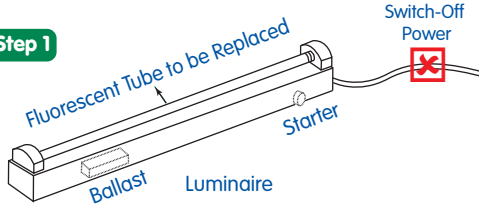

Step 2

Remove Fluorescent Tube and Recycle. Refer to the EPA.gov website for Fluorescent Tube Recycling instructions.

Remove Ballast and Starter (if so equipped)

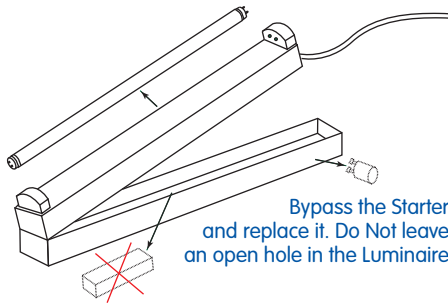

Step 3

Luminaire with Magnetic Ballast & Starter

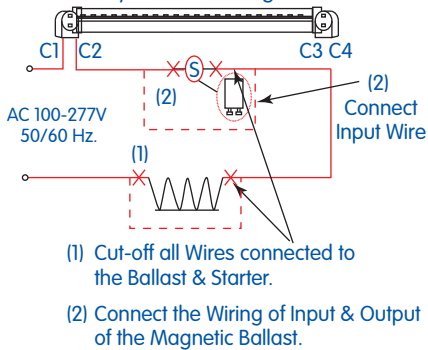

For Wiring Connection: As per Step 3 or 4

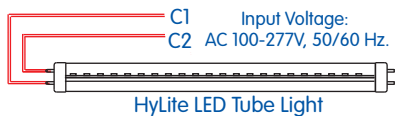

Step 4

Luminaire with Electronic Ballast

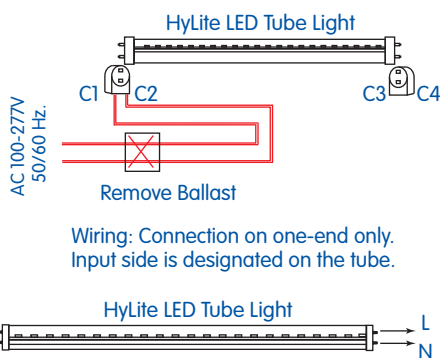

Input Voltage (V)	100-277V, AC
Input Frequency	50~60Hz
Power Factor	>0.93
IP Rating	42
Beam Angle	120°
Operating Temperature	-4°F~140°F (-20°C~60°C)
Humidity Range	10%~90%

Caution: HyLite LED Tube Lights are designed to work off 100V to 277V. Ballast and Starter (if equipped) **must** be bypassed or removed from the fixture before installing tube. Failure to follow instruction can result in a damaged product, electric shock, or fire. Eliminating the Ballast saves additional costs related to maintenance, energy consumption and performance. By-passing Ballast will also ensure that there is no RF interference.

Warning: Important Safety Instructions. Risk of Fire or Electric Shock. Read and Understand all Installation Instructions before installing HyLite T8 LED Tube Light. HyLite LED Bi-pin tube lights are designed for Single-End power. Only one end of the tube is designated as the input side. Please ensure only this end is installed in the powered lamp holder. DO NOT Remove Cover and/or End Caps. No User-Serviceable Parts inside.

Thank you for purchasing HyLite LED Tube Light and for investing in the future of eco-friendly products. By selecting HyLite LED Tube Light you have chosen a high-quality, eco-friendly product that is designed for years of dependable performance. We trust you will experience years of reliable service from it.

This guide explains the steps necessary to install or retrofit the T8/T10/T12 tube lights to ensure optimal performance. This guide is for reference only and is intended for qualified electricians or lighting technicians. HyLite LED Tube Lights are intended to retrofit maximum four lamps, surface mount, or Non-IC recessed mount fluorescent luminaires that use straight tubular Tube Lights.

- To be used in indoor dry or damp location only. Not suitable for wet location. Do not use where directly exposed to water or weather. Non-submergible (not water tight). Not for use in fully enclosed fixtures. Operate in fixtures that provide the free flow of air around the lamp heat sink.
- For use with Non-shunted "tombstones" only. Do not use in Luminaires employing Shunted Bi-pin lampholders (tombstones). Not to be used with a light dimmer. Ballasts and Starters **must** be bypassed.
- Not intended for use with emergency exit fixtures or emergency exit lights.
- HyLite LED Tube Lights should only be installed by a Qualified Electrician / Lighting Technician and in accordance with all the applicable installation codes. Always contact ground lead to luminaire in accordance with national, state, and/or local electrical codes where applicable. Failure to do so may result in a serious personal injury.
- Disable all power to the luminaire before conducting any inspection, installation, maintenance or removal. Failure to do so will create a hazardous and fatal working environment.
- The installer must determine and verify whether they have AC 100~277V at the luminaire before installation. Improper voltage matching can result in performance degradation and/or physical damage. These lamps work on line voltage and require all Ballasts and Starters to be bypassed.
- Luminaires wiring, ballasts, or other electrical parts may be damaged when installing. Always check for enclosed wiring and components.
- To prevent wiring damage or abrasion, do not expose wiring to edges of sheet metal or other sharp objects.
- Do not make or alter any open holes in an enclosure of wiring or electrical components during installation.
- Do not open – no user serviceable parts inside.
- The end retrofit fixture once modified can no longer operate as was originally intended.

Step 5

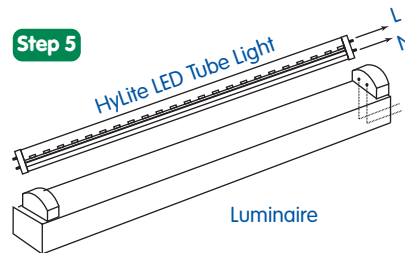

Step 7

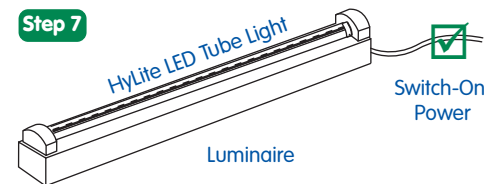

Step 6

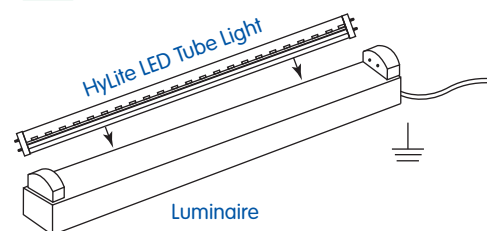

Note: HyLite LED Bi-Pin Tubes are designed to work with Non-shunted tombstones only.
The Luminaire, once modified as a retrofit fixture, will no longer operate fluorescent lamps.

Bi-Pin Steps:

1. Ensure Breaker is turned off and no power is going to the fixture (**Step 1**).
2. Remove Fluorescent Tube and Recycle.
3. Open/Remove Wiring Compartment Cover and cut-off all wires connected to the Ballast. Remove the Ballast (**Step 2**).
4. Connect the wires as shown in (**Step 3**) and (**Step 4**).
5. Adapt one-end wiring method as shown in (**Step 5**) before installing LED tube light.
 - a. Live Wire "L" and Neutral Wire "N", should be separately connected to any one wire of C1 or C2.
 - b. The wire "L" and wire "N" can be separately connected to more than one wire from C1 or C2.
 - c. To avoid the risk of electric shock, **DO NOT** connect wires "L" and "N" together.
 - d. Use approved Electrical Insulating Tape or wire cap to ensure that all the power cords which were cut are well insulated or capped. An energized wire is a shock and a fire hazard.
6. Close-up the Wiring Compartment (**Step 5**).
7. Insert HyLite LED Tube Light in the lamp holder (**Step 6**).
Note: HyLite Tube Light is single-end powered. Check the tube to ensure the "Input" end is installed in the lamp holder with the line and neutral installed.
8. Once installation is complete, switch-on Power (**Step 7**).



Retrofit Luminaire with One Tube

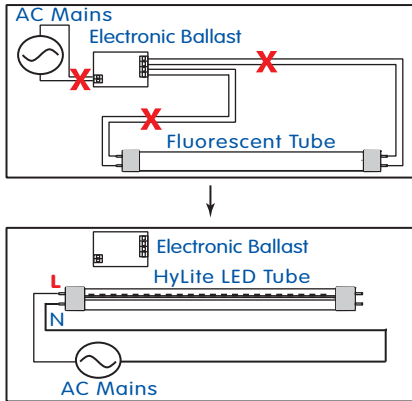

Retrofit Luminaire with Three or Four Tubes and One Ballast

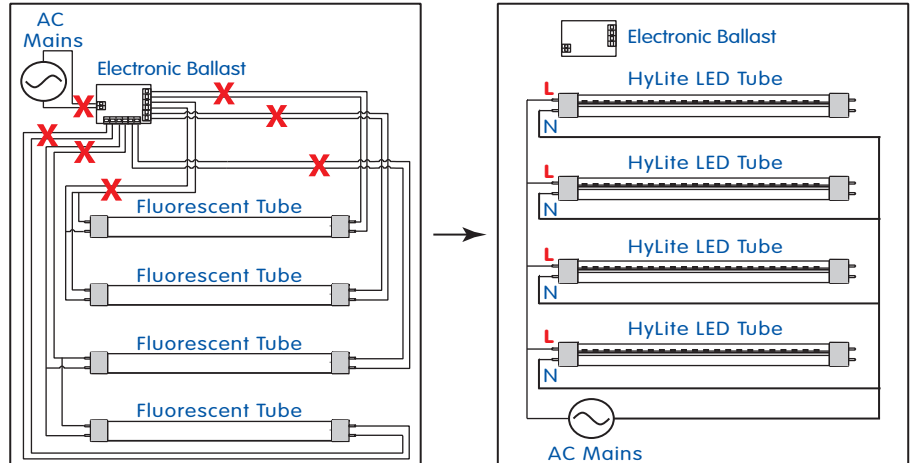

Retrofit Luminaire with Two Tubes and One Ballast

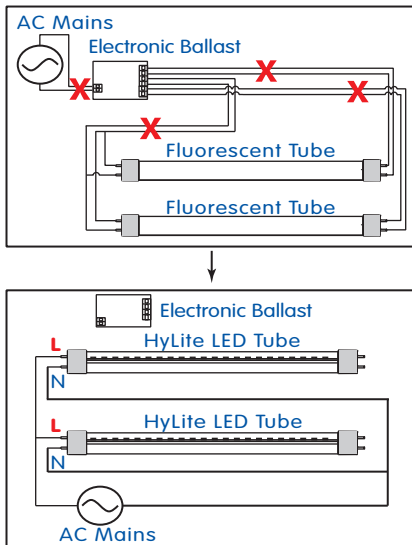

Retrofit Luminaire with Three or Four Tubes and Two Ballasts

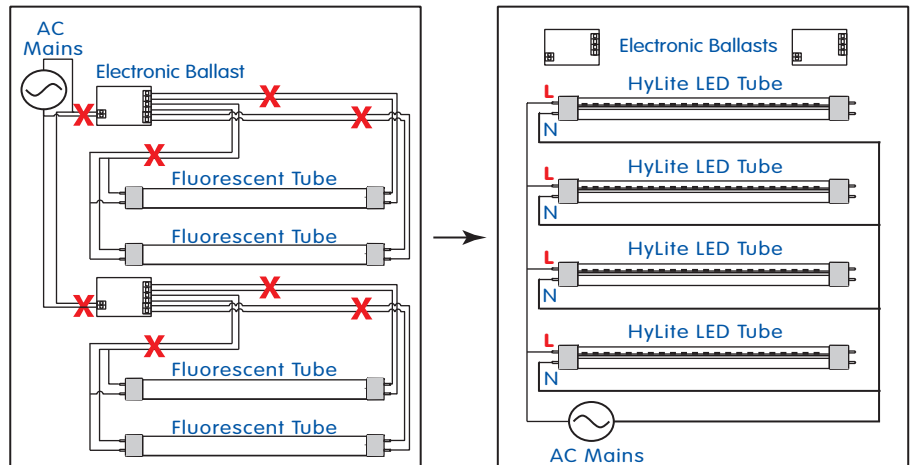

Single Pin Steps:

1. Ensure Breaker is turned off and no power is going to the fixture.
2. Remove Fluorescent Tube and Recycle.
3. Open/Remove Wiring Compartment Cover and cut-off all wires connected to the Ballast. Remove the Ballast.
4. Connect the "Live" wire to one end of lamp holder and connect the "Neutral" to the other end of lamp holder.
 - a. To avoid the risk of electric shock, **DO NOT** connect wires "L" and "N" together.
 - b. Use approved Electrical Insulating Tape or wire cap to ensure that all the power cords which were cut are well insulated or capped. An energized wire is a shock and a fire hazard.
5. Close-up the Wiring Compartment.
6. Insert HyLite LED Tube Light in the lamp holder.
7. Once installation is complete, switch-on Power.



For One Single Pin Tube

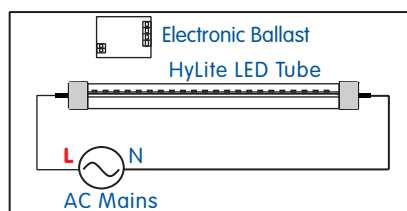

For Two Single Pin Tubes

