

Project Name:	Type:
Part Number:	Date:



GREENCREATIVE

CCT SELECT T8 EXT (UL TYPE C)

FEATURES

- Replaces 2', 3', and 4' T8 fluorescent lamps
- Compatible with GREEN CREATIVE external drivers only
- Parallel output driver requires no minimum lamp load to operate properly
- Suitable for single-ended installation with non-shunted lamp holders, as well as double-ended installation compatible with both existing shunted and non-shunted lamp holders.
- Frosted glass tube optimizes light distribution
- Flicker Free (percent flicker and flicker index are less than three percent)
- Exceptional efficacy up to 158 LPW
- Lumen output up to 2,050lm for 4' model
- SelectDrive technology - field selectable five lumen output levels
- 0-10V dimming* - dims to OFF with SelectDrive driver, dims to 10% with single wattage driver
- Options of additional control systems
- SelectKelvin technology - field selectable color temperature in 3000K, 3500K, 4000K, 5000K, and 6500K
- L70 rated lifetime up to 60,000 hours
- 5 year limited warranty** / Optional 10 year available (see EXTENDED WARRANTIES table for information)
- Suitable for use in totally enclosed fixtures and damp locations
- Fixture operating temperature: -4°F to 95°F (-20°C to 35°C)
- Lamp ambient temperature: -4°F to 113°F (-20°C to 45°C)
- NSF (National Sanitation Foundation) certified for Food Zone (Non-Contact), Splash, and Non-Food Zones

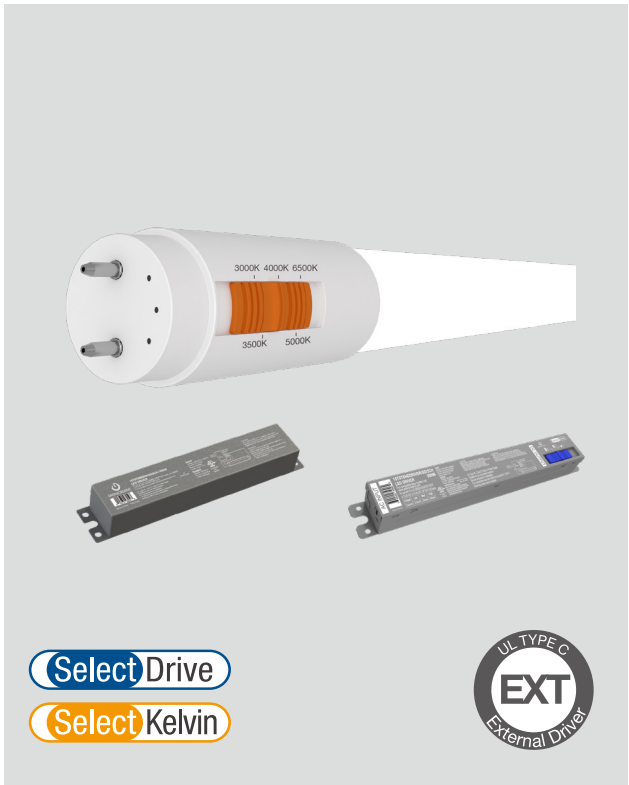

SelectDrive
SelectKelvin



FOCUS FEATURE

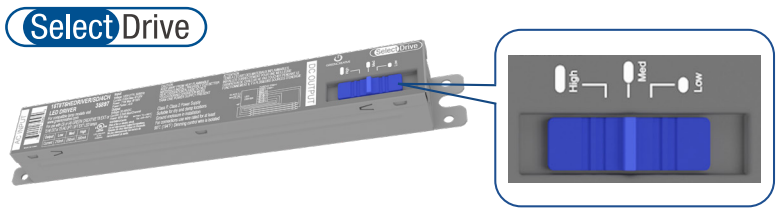
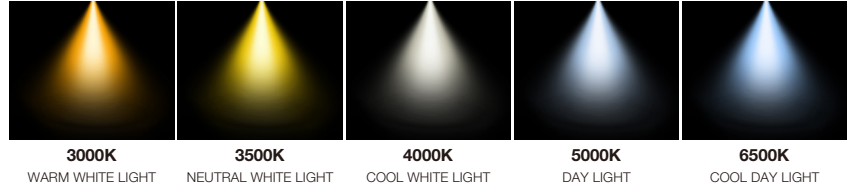
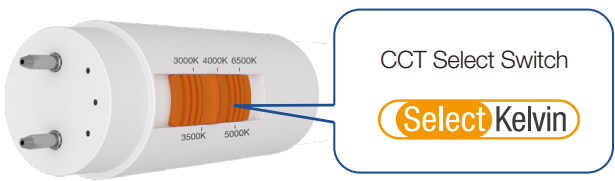

Selectable output			
Output	Low	Med	High
Current	210mA	250mA	300mA

SPECIFICATIONS

EXTERNAL DRIVER

Product	Model	Max. Lamp Quantity	Input Voltage	Input Freq. (Hz)	Max. Input Current (A)	Output Voltage(V)	Output Current (mA)	Dim	Max Case Temperature (°C/°F)	Power Factor	THD
35896	15T8T5HEDRIVER/SD/2CH	2	120-277V	50/60	0.31	30-48VDC	300mA/250mA/210mA (+/-5%)*2	0-10V	90/194	0.9	<20%
35897	15T8T5HEDRIVER/SD/4CH	4	120-277V	50/60	0.60	30-48VDC	300mA/250mA/210mA (+/-5%)*4	0-10V	90/194	0.9	<20%
98259	15T8T5HEDRIVER/2CH/R	2	120-277V	50/60	0.31	30-48VDC	300mA (+/-5%)*2	0-10V	90/194	0.9	<20%
98260	15T8T5HEDRIVER/4CH/R	4	120-277V	50/60	0.6	30-48VDC	300mA (+/-5%)*4	0-10V	90/194	0.9	<20%



CCT SELECT T8 EXT (UL TYPE C)

SPECIFICATIONS

LAMP

Product	Model	Nominal Length	Equiv.	Input Voltage	Wattage	Lumens	CCT	Efficacy (LPW)	Life (hrs)	CRI	Power Factor	THD	Beam Angle	Fixture Rating	Dim.*	DLC / NSF
37223	9.5T8/2F/8CCTS/EXT	2'	17W	120-277V	9.5	1,350	3000K	142	60,000	82	0.9	<20%	220°	Enclosed	Yes	√/√
						1,400	3500K	147								
						1,500	4000K	158								
						1,500	5000K	158								
						1,500	6500K	158								
37224	10.5T8/3F/8CCTS/EXT	3'	25W	120-277V	10.5	1,450	3000K	138	60,000	82	0.9	<20%	220°	Enclosed	Yes	√/√
						1,500	3500K	143								
						1,600	4000K	152								
						1,600	5000K	152								
						1,600	6500K	152								
37225	11.5T8/4F/8CCTS/EXT	4'	32W	120-277V	11.5	1,600	3000K	139	60,000	82	0.9	<20%	220°	Enclosed	Yes	√/√
						1,650	3500K	143								
						1,700	4000K	148								
						1,700	5000K	148								
						1,700	6500K	148								
37226	14T8/4F/8CCTS/EXT	4'	32W	120-277V	14	1,920	3000K	137	60,000	82	0.9	<20%	220°	Enclosed	Yes	√/√
						2,000	3500K	143								
						2,050	4000K	146								
						2,050	5000K	146								
						2,050	6500K	146								

LAMP & DRIVER - COMPATIBLE TABLE

Product	Model	15T8T5HEDRIVER/2CH/R; 15T8T5HEDRIVER/SD/2CH	15T8T5HEDRIVER/4CH/R; 15T8T5HEDRIVER/SD/4CH
37223	9.5T8/2F/8CCTS/EXT	1 lamp / 2 lamps	1 lamp / 2 lamps / 3 lamps / 4 lamps
37224	10.5T8/3F/8CCTS/EXT	1 lamp / 2 lamps	1 lamp / 2 lamps / 3 lamps / 4 lamps
37225	11.5T8/4F/8CCTS/EXT	1 lamp / 2 lamps	1 lamp / 2 lamps / 3 lamps / 4 lamps
37226	14T8/4F/8CCTS/EXT	1 lamp / 2 lamps	1 lamp / 2 lamps / 3 lamps / 4 lamps

LAMP & DRIVER SYSTEM - LUMEN OUTPUT GUIDE

Product	Model	CCT	15T8T5HEDRIVER/2CH/R; 15T8T5HEDRIVER/SD/2CH				15T8T5HEDRIVER/4CH/R; 15T8T5HEDRIVER/SD/4CH						
			1 Lamp		2 Lamps		3 Lamps		4 Lamps				
			System Power	Lumens	System Power	Lumens	System Power	Lumens	System Power	Lumens			
37223	9.5T8/2F/8CCTS/EXT	3000K	11	1,350	22	2,700	33	4,050	44	5,400			
		3500K									2,800	4,200	5,600
		4000K									3,000	4,500	6,000
		5000K									3,000	4,500	6,000
		6500K									3,000	4,500	6,000
37224	10.5T8/3F/8CCTS/EXT	3000K	12	1,450	24	2,900	36	4,350	48	5,800			
		3500K									3,000	4,500	6,000
		4000K									3,200	4,800	6,400
		5000K									3,200	4,800	6,400
		6500K									3,200	4,800	6,400
37225	11.5T8/4F/8CCTS/EXT	3000K	13	1,600	26	3,200	39	4,800	52	6,400			
		3500K									3,300	4,950	6,600
		4000K									3,400	5,100	6,800
		5000K									3,400	5,100	6,800
		6500K									3,400	5,100	6,800
37226	14T8/4F/8CCTS/EXT	3000K	16	1,920	32	3,840	48	5,760	64	7,680			
		3500K									4,000	6,000	8,000
		4000K									4,100	6,150	8,200



CCT SELECT T8 EXT (UL TYPE C)

SPECIFICATIONS

LAMP & SelectDrive DRIVER SYSTEM - LUMEN OUTPUT GUIDE

Product	Model	CCT	15T8T5HEDRIVER/SD/2CH; 15T8T5HEDRIVER/SD/4CH								
			Low (Lamp Power)	Low (System Power)	Low (Lumens)	Med (Lamp Power)	Med (System Power)	Med (Lumens)	High (Lamp Power)	High (System Power)	High (Lumens)
			1 Lamp								
37223	9.5T8/2F/8CCTS/EXT	3000K	6.7	8.0	900	7.9	9.5	1,100	9.5	11	1,350
		3500K			950			1,150			1,400
		4000K			1,000			1,200			1,500
		5000K			1,000			1,200			1,500
		6500K			1,000			1,200			1,500
37224	10.5T8/3F/8CCTS/EXT	3000K	7.4	8.6	950	8.8	10.2	1,150	10.5	12	1,450
		3500K			1,000			1,200			1,500
		4000K			1,050			1,300			1,600
		5000K			1,050			1,300			1,600
		6500K			1,050			1,300			1,600
37225	11.5T8/4F/8CCTS/EXT	3000K	8.1	9.3	1,050	9.6	11.0	1,300	11.5	13	1,600
		3500K			1,100			1,350			1,650
		4000K			1,150			1,400			1,700
		5000K			1,150			1,400			1,700
		6500K			1,150			1,400			1,700
37226	14T8/4F/8CCTS/EXT	3000K	9.8	11.0	1,245	11.7	13.0	1,535	14	16	1,920
		3500K			1,300			1,600			2,000
		4000K			1,400			1,650			2,050
		5000K			1,400			1,650			2,050
		6500K			1,400			1,650			2,050

* This lamp might not be compatible with all dimmers. Please visit www.greencreative.com for compatibility information.

** Please visit www.greencreative.com for Limited Warranty terms

DIMENSION & WEIGHT

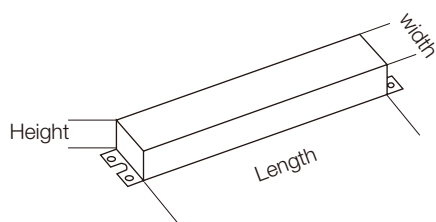

Model	Length	MOL	Dia.	Weight
15T8T5HEDRIVER/SD/2CH	9-1/2"	1-5/16"	1-3/16"	1.0 lb
15T8T5HEDRIVER/SD/4CH				
15T8T5HEDRIVER/2CH/R				
15T8T5HEDRIVER/4CH/R				

Model	Base	MOL	Dia.
9.5T8/2F/8CCTS/EXT	G13	23-3/4"	1-1/8"
10.5T8/3F/8CCTS/EXT	G13	35-3/4"	1-1/8"
11.5T8/4F/8CCTS/EXT	G13	47-3/4"	1-1/8"
14T8/4F/8CCTS/EXT	G13	47-3/4"	1-1/8"

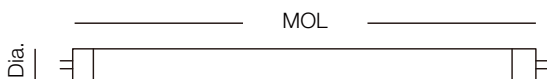

FULHAM EMERGENCY DRIVER PERFORMANCE

Type	Model No	FULHAM EM DRIVER		
		Lumen output level at EM mode		
		FHSCP-UNV-10.7WL	FHSCP-UNV-13.7WL	FHSCP-UNV-17WL
T8	9.5T8/2F/8XX/EXT	113%	-	-
	10.5T8/3F/8XX/EXT	102%	-	-
	11.5T8/4F/8XX/EXT 11.5T8/4F/xxx/EXT/R	93%	-	-
	14T8/4F/8XX/EXT 14T8/4F/8XX/EXT/R	76%	98%	-
	14.5T8U6/8XX/EXT	74%	94%	117%



CCT SELECT T8 EXT (UL TYPE C)

INSTALLATION

SINGLE ENDED EXTERNAL DRIVER INSTALLATION

Suitable for use with Non-Shunted lamp holders only.

Programmed Start or Rapid Start
(Non-Shunted Lamp Holders)

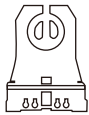

Instant Start
(Shunted Lamp Holders)

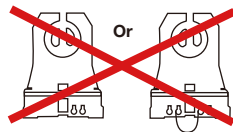

Step 1. Cut all wires connected to the existing ballast, and remove the ballast.

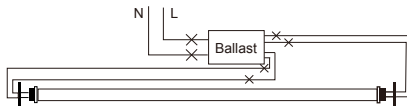

Single Lamp

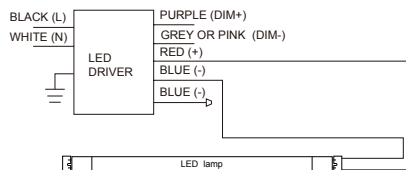

Not polarity sensitive, lamps can be wired at either end

Multiple Lamps
Maximum 4 tubes should be interconnected.

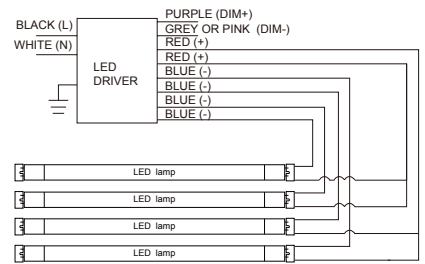

Not polarity sensitive, lamps can be wired at either end

DOUBLE ENDED EXTERNAL DRIVER INSTALLATION

Suitable for use with both Non-Shunted or Shunted lamp holders.

Programmed Start or Rapid Start
(Non-Shunted Lamp Holders)

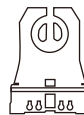

Step 1. Cut all wires connected to the existing ballast, and remove the ballast.

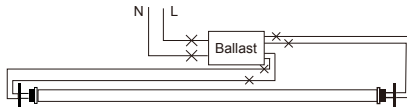

Single Lamp

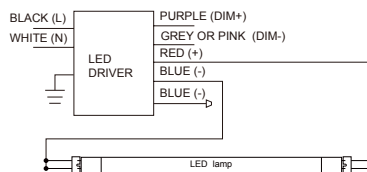

Not polarity sensitive, lamps can be wired at either end

Multiple Lamps
Maximum 4 tubes should be interconnected.

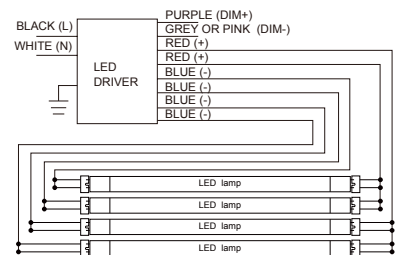

Not polarity sensitive, lamps can be wired at either end

Instant Start
(Shunted Lamp Holders)

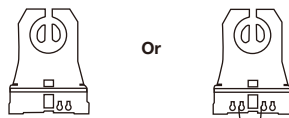

Step 1. Cut all wires connected to the existing ballast, and remove the ballast.

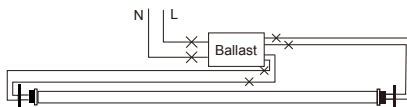

Single Lamp

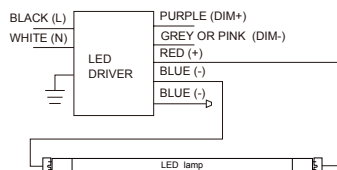

Not polarity sensitive, lamps can be wired at either end

Multiple Lamps
Maximum 4 tubes should be interconnected.

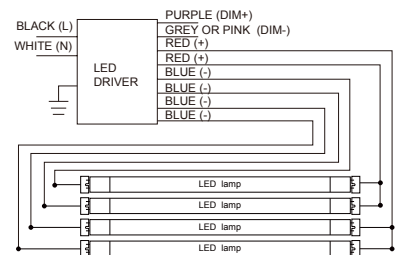

Not polarity sensitive, lamps can be wired at either end



CCT SELECT T8 EXT (UL TYPE C)

FULHAM EMERGENCY DRIVER INSTALLATION

1 LAMP

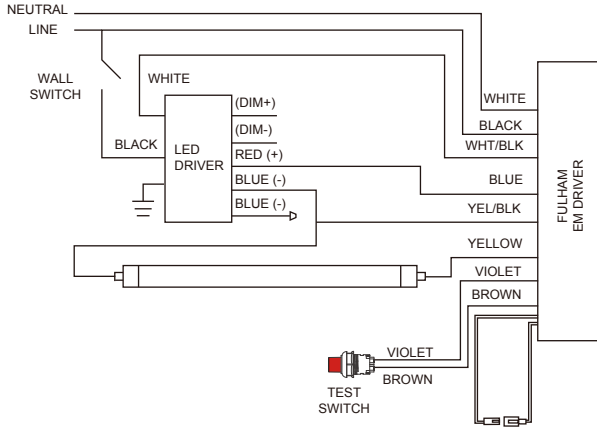

1 LAMP

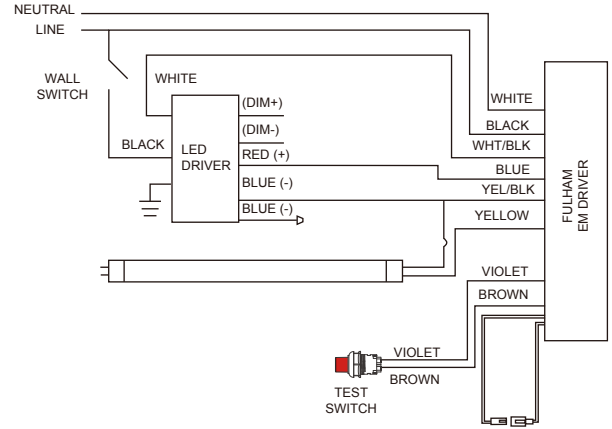

4 LAMPS

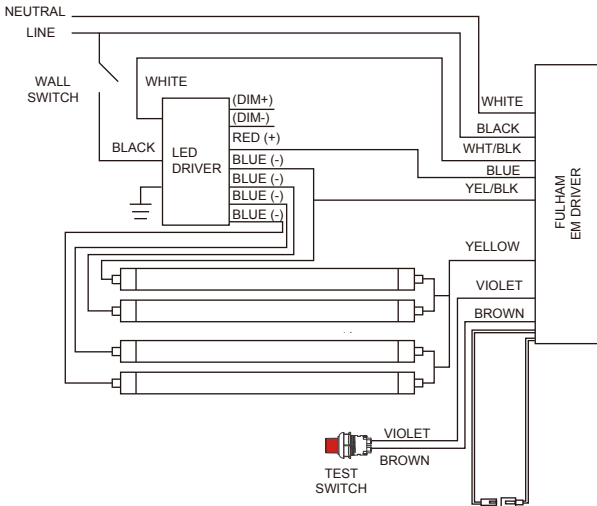

4 LAMPS

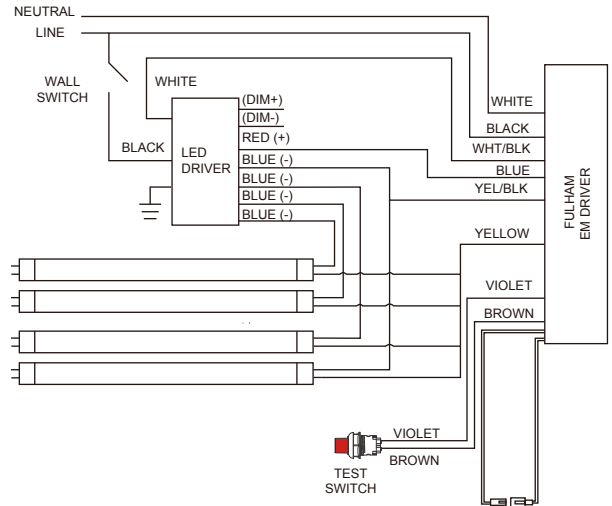



CCT SELECT T8 EXT (UL TYPE C)

COMPATIBLE CONTROL SYSTEM CONTROL ORDERING INFORMATION

Product	Model	Description	Picture	Dimension
98517	PH-SRB-LD	Xitanium SR Bridge - Side Entry - Field installation and Wiring		
98518	PH-SNS2000CMP	Easy Sense Ceiling Mount Sensor (SNS200) - Field installation and Wiring		
KIT-SU-5E-D-CL	KIT-SU-5E-D-CL	Enlighted SU-5E Micro Sensor With 2-Wire Connection, Connected Lighting - Field installation and Wiring		
KIT-SU-5E-D-IL	KIT-SU-5E-D-IL	Enlighted SU-5E Micro Sensor With 2-Wire Connection, Enlighted One - Field installation and Wiring		
KIT-SU-5E-D-IOT	KIT-SU-5E-D-IOT	Enlighted SU-5E Micro Sensor With 2-Wire Connection, IoT Node - Field installation and Wiring		
HCMC-SU-5E	HCMC-SU-5E	Carrier for mounting KI-SU-5E-D Micro sensor in thick materials such as drywalls, ceiling tiles, plywood, etc – Field installation		

CONTROL SYSTEM INSTALLATION

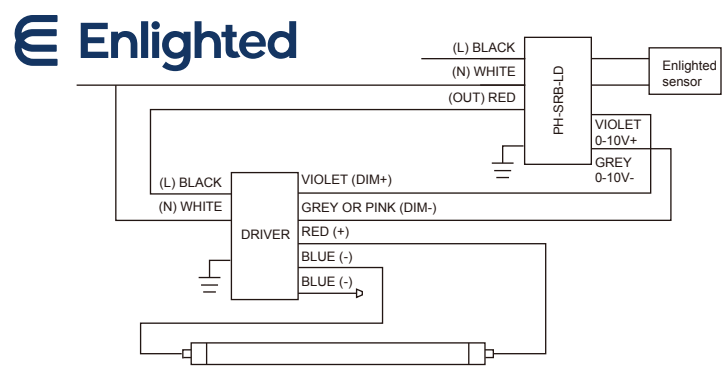
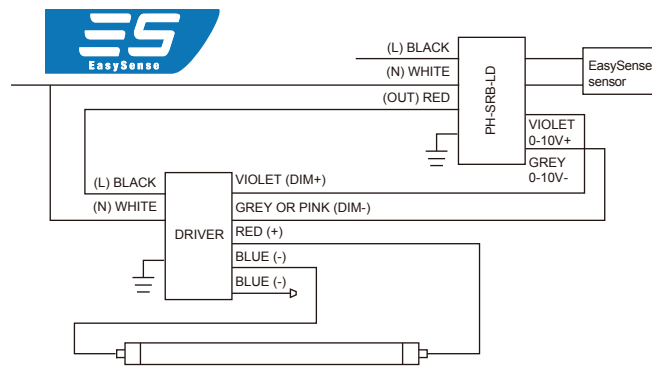







CCT SELECT T8 EXT (UL TYPE C)

ORDERING INFORMATION

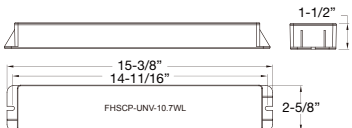
Product Series	Master Carton			Shipping Carton		
	Case QTY	Case Dimensions (LxWxH)	Case Weight	Case QTY	Case Dimensions (LxWxH)	Case Weight
9.5T8/2F/8CCTS/EXT	N.A	N.A	N.A	25	25-1/4" x 8-1/16" x 8-1/16"	7.32 lb
10.5T8/3F/8CCTS/EXT	N.A	N.A	N.A	25	37-5/16" x 8-1/16" x 8-1/16"	10.47 lb
11.5T8/4F/8CCTS/EXT	N.A	N.A	N.A	25	37-5/16" x 8-1/16" x 8-1/16"	13.51 lb
14T8/4F/8CCTS/EXT	N.A	N.A	N.A	25	49-3/16" x 8-1/16" x 8-1/16"	13.51 lb
15T8T5HEDRIVER/SD/2CH	6	9-7/8 x 5-5/8"x 2-3/4"	5.07 lb	24	11-7/8" x 10-5/16" x 6-11/16"	20.83 lb
15T8T5HEDRIVER/SD/4CH	6	9-7/8 x 5-5/8"x 2-3/4"	5.40 lb	24	11-7/8" x 10-5/16" x 6-11/16"	22.16 lb
15T8T5HEDRIVER/2CH/R	6	9-7/8 x 5-5/8"x 2-3/4"	5.40 lb	24	11-7/8" x 10-5/16" x 6-11/16"	22.60 lb
15T8T5HEDRIVER/4CH/R	6	9-7/8 x 5-5/8"x 2-3/4"	6.06 lb	24	11-7/8" x 10-5/16" x 6-11/16"	25.13 lb

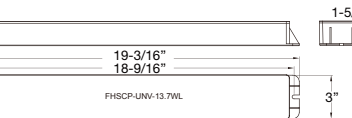
ACCESSORY ORDERING INFORMATION

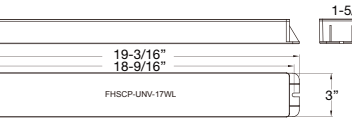
Product	Model	Description	Picture	Dimension
35797	FU10W/T5T8/EXT/EMDRIVER	FHSCP-UNV-10.7WL		
35798	FU13W/T5T8/EXT/EMDRIVER	FHSCP-UNV-13.7WL		
35799	FU17W/T5T8/EXT/EMDRIVER	FHSCP-UNV-17WL		

EXTENDED WARRANTIES***

Model	Description
9.5T8/2F/8CCTS/EXT/10YEARWARRANTY	10 Year warranty for 9.5T8/2F/8CCTS/EXT/yy
10.5T8/3F/8CCTS/EXT/10YEARWARRANTY	10 Year warranty for 10.5T8/3F/8CCTS/EXT/yy
11.5T8/4F/8CCTS/EXT/10YEARWARRANTY	10 Year warranty for 11.5T8/4F/8CCTS/EXT/yy
14T8/4F/8CCTS/EXT/10YEARWARRANTY	10 Year warranty for 14T8/4F/8CCTS/EXT/yy

*** Warranty based on a maximum of 4,368 annual operating hours (per year for ten years) and exposure to a maximum fixture operating temperature of 80°F / 27°C.

**CCT SELECT T8 EXT (UL TYPE C)**

DLC KITS REFERENCES				
Model No. (DLC)	Lamp Model	Lamp Qty	External Driver Model	DLC Product ID
T8 2'				
9.5T8/2F/8CCTS/EXT/SD/A2	9.5T8/2F/8CCTS/EXT	2	15T8T5HEDRIVER/SD/2CH	S-A4TCM2
9.5T8/2F/8CCTS/EXT/SD/A3		3	15T8T5HEDRIVER/SD/4CH	S-2Z5DC1
9.5T8/2F/8CCTS/EXT/SD/A4		4		S-9Q5EGK
T8 3'				
10.5T8/3F/8CCTS/EXT/SD/A2	10.5T8/3F/8CCTS/EXT	2	15T8T5HEDRIVER/SD/2CH	S-CXYAPM
T8 4'				
11.5T8/4F/8CCTS/EXT/A2	11.5T8/4F/8CCTS/EXT	2	15T8T5HEDRIVER/2CH/R	S-AHTCBD
11.5T8/4F/8CCTS/EXT/A3		3	15T8T5HEDRIVER/4CH/R	S-W8MVAY
11.5T8/4F/8CCTS/EXT/A4		4		S-KQ2MW0
11.5T8/4F/8CCTS/EXT/SD/A2		2	15T8T5HEDRIVER/SD/2CH	S-KDCTRP
11.5T8/4F/8CCTS/EXT/SD/A3		3	15T8T5HEDRIVER/SD/4CH	S-803GYW
11.5T8/4F/8CCTS/EXT/SD/A4		4		S-0KFHQ8
14T8/4F/8CCTS/EXT/SD/A2	14T8/4F/8CCTS/EXT	2	15T8T5HEDRIVER/2CH/R	S-LGHKEU
14T8/4F/8CCTS/EXT/SD/A3		3	15T8T5HEDRIVER/4CH/R	S-Z5S06X
14T8/4F/8CCTS/EXT/SD/A4		4		S-ESTP32

Note: All rights reserved. All sizes and specifications are subject to change at any time without notice.